

LiberoPro Flat Induction 1 Phase, mono zone

ITEM # _____

MODEL # _____

NAME # _____

SIS # _____

AIA # _____

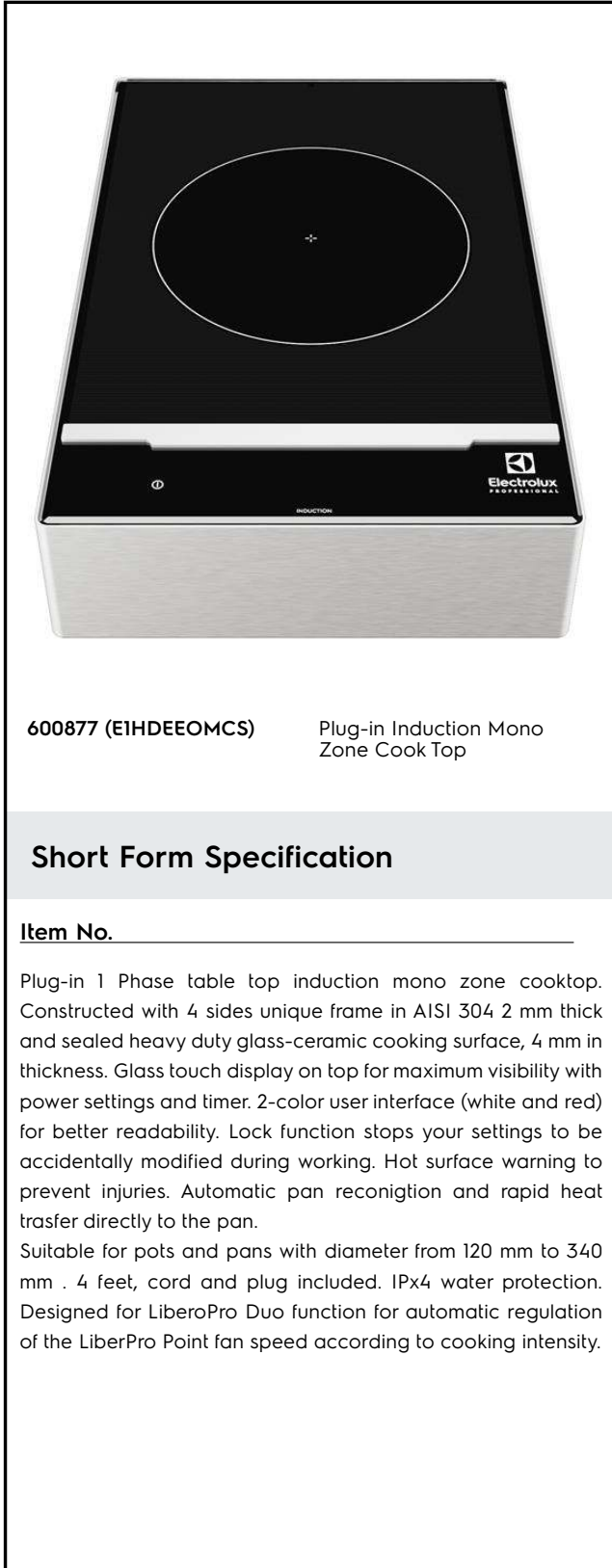
600877 (EIHDEEOMCS)

 Plug-in Induction Mono
 Zone Cook Top

Short Form Specification

Item No. _____

Plug-in 1 Phase table top induction mono zone cooktop. Constructed with 4 sides unique frame in AISI 304 2 mm thick and sealed heavy duty glass-ceramic cooking surface, 4 mm in thickness. Glass touch display on top for maximum visibility with power settings and timer. 2-color user interface (white and red) for better readability. Lock function stops your settings to be accidentally modified during working. Hot surface warning to prevent injuries. Automatic pan reconigition and rapid heat trasfer directly to the pan.

Suitable for pots and pans with diameter from 120 mm to 340 mm . 4 feet, cord and plug included. IPx4 water protection. Designed for LiberoPro Duo function for automatic regulation of the LiberPro Point fan speed according to cooking intensity.

Main Features

- Plug in unit designed for table top installations.
- Sealed heavy duty glass-ceramic cooking surface, 4 mm in thickness.
- 2-color user interface (white and red) for better readability.
- Rapid heat trasfer directly to the pan, no heat is dispersed into the environment.
- Automatic pan detection to transfer power only when pan is present.
- Glass touch display on top for maximum visibility.
- Power level settings from 1 to 10.
- Timer function can be used to set the cooking time, switching off the zone automatically at the end of the time set.
- Suitable for pot and pan with diameter from 120 mm to 340mm.
- Self-diagnostics: an error code is displayed (Exxx) in case of dysfunction.
- Designed for LiberoPro Duo function for automatic regulation of the LiberPro Point fan speed according to cooking intensity.

Construction

- 4 sides unique frame in AISI 304 2 mm thick.
- Induction air filters easy to clean and remove for monthly cleaning.
- 4 feet, cord and plug included.
- IPx4 water protection.

Sustainability



- This model is compliant with Swiss Energy Efficiency Ordinance (730.02).

Optional Accessories

- Stainless steel universal frying pan with stainless steel handle (diam. 200mm) suitable for induction and all other heating sources PNC 653596
- Universal frying pan with stainless steel handle (diam. 240mm) suitable for induction and all other heating sources PNC 653597
- Universal frying pan with stainless steel handle (diam. 280mm) suitable for induction and all other heating sources PNC 653598
- Universal frying pan with ribbed plate suitable for induction cookers PNC 653618

APPROVAL: _____

Top

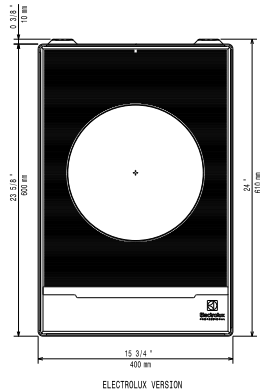

Side

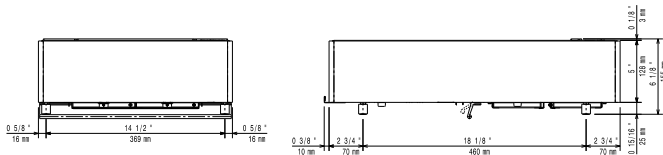

EI = Electrical inlet (power)
EO = Electrical Outlet

Other

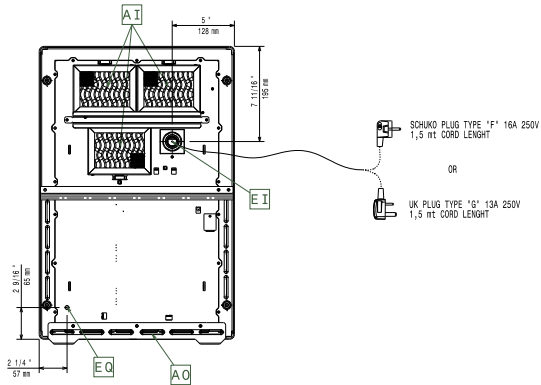

Electric

Supply voltage:

600877 (EIHDEEOMCS) 220-240 V/1N ph/50-60 Hz

Total Watts:

3.5 kW

Plug type:

CE-SCHUKO

Minimum Circuit Ampacity (MCA):

13A

Key Information:

External dimensions, Width: 400 mm

External dimensions, Depth: 369 mm

External dimensions, Height: 152 mm

Net weight: 19.5 kg